

## Electromagnetic compatibility of PLC adapters for in-home/domestic networks

**Lukas Potisk<sup>\*</sup>, Jozef Hallon<sup>\*\*</sup>,**  
**Milos Orgon<sup>\*\*\*</sup>, Radek Fujdiak<sup>\*\*\*\*, \*\*\*\*\*</sup>**

The use of programable logic controllers (PLC) technology in electrical networks 230 V causes electromagnetic radiation that interferes with other electrical equipment connected to the network [1–4]. Therefore, this article describes the issues of electromagnetic compatibility (EMC) of new PLC adapters used in IP broadband services in a multi-user environment. The measurements of disturbing electromagnetic field originated in PLC adapters were made in a certified laboratory EMC (laboratory of electromagnetic compatibility) in the Institute of Electrical Engineering at Faculty of Electrical Engineering and Information Technology of the Slovak University of Technology in Bratislava. The measured spectra of the radiated electromagnetic field will be compared with the results obtained when testing older PLC modems [5].

**Key words:** PLC, home appliances, domestic networks

### 1 Introduction

With the more extensive usage and spreading of communication, the infrastructure is also spreading the offer of broadband services. The number of different types of devices connected to the internet has increased. Accordingly to this fact, the various scale of wired and wireless technologies used by customers has also increased. In the case of using PLC technology the upper limit of frequency band increased from 30 MHz to 100 MHz which increased a transfer rate. PLC technology, in detail is described and discussed in [1, 6–16] where examples of usage are shown.

Except for wired and wireless communication devices connected to IP network there can be also connected different devices like televisions and other types of electronics [1]. All of these electronic devices and electric appliances are often placed close to each other what caused serious worries about electromagnetic compatibility (EMC) because of the possibility of negative effects of electromagnetic disturbance unconsciously emitted from different types of electric devices used in households [17]. Because of the increase of those devices the problem of EMC is more and more serious. Very important are ongoing works focused on quality of service (QoS) in upper layers of OSI reference model (open systems interconnection) to ensure the quality of IP telecommunication networks [18, 19]. The control of the quality of technology should start with ensuring the quality on lower layers of

OSI reference model (physical layer, data link layer and network layer).

The resistance requirements of telecommunication devices to electromagnetic disturbance are defined in the international [20–24] and national standards [25–32]. Therefore it is necessary to define the limits of disturbance voltage in electromagnetic signal because there are so many examples of IP devices, which failed because of disturbing voltage in the form of impulse interference caused by switching on or off of electric devices and electric appliances. The effect of impulse noise can be also caused by other electric devices. We can find some cases with interruption of VDSL connection (very high bitrate digital subscriber line) caused by impulse noise coming from damaged light bulbs [33], disablement of telecommunication lines caused by impulse noise from lift or connection or disconnection reserved power systems. This noise can also cause pixelation of transmitted video in IPTV services provided by ASDL lines (asymmetric digital subscriber line) [1, 21]. That is the reason why the finding of the solution provided a protection of impulse noise happened an urgent problem.

All of these cases have in common the fact that unsuspecting impulse noise and his immediate noise peaks in domestic areas are caused by electric devices or by damaged parts of devices. Video communication and other similar services are especially sensitive to impulse noise, because these services require operations in real-time and they also need a high level of reliability. Although recent

---

<sup>\*</sup> Institute of Telecommunications, Faculty of Electrical Engineering and Information Technology, Slovak University of Technology, Ilkovičova 3, 812 19 Bratislava, Slovakia, lukas.potisk@institution.edu <sup>\*\*</sup> Institute of Electrical Engineering, Faculty of Electrical Engineering and Information Technology, Slovak University of Technology, Ilkovičova 3, 812 19 Bratislava, Slovakia, jozef.hallon@stuba.sk <sup>\*\*\*</sup> Institute of Telecommunications, Faculty of Electrical Engineering and Information Technology, Slovak University of Technology, Ilkovičova 3, 812 19 Bratislava, Slovakia, orgon@ktl.elf.stuba.sk <sup>\*\*\*\*</sup> Department of Telecommunications, Brno University of Technology, Technická St. 12, 616 00 Brno, Czech Republic <sup>\*\*\*\*\*</sup> Peoples Friendship University of Russia (RUDN University) 6 Miklukho-Maklaya St, Moscow, 117198, Russian Federation

standards [25, 27, 28, 30] require uninterrupted normal operation of these devices with constantly emitted electromagnetic radiation (contains impulse noise too) [1–4]. There can occur some cases when the operation of these devices is interrupted or failed [1]. The main question is ensuring of electromagnetic compatibility in IP networks to harmonize the requirements of EMC standards and requirements of video and other broadband services, which require a high level of reliability in real time. That is the reason why is testing of PLC adapters interesting and necessary.

The issues of regulation or standardization of communication using PLC technology is important and it is still discussed in many normalization organizations and mainly in CISPR I where the main goal is to change the standard EN 55022: 2010 which since 2017 replaced standard EN 55032:2015 (Electromagnetic compatibility of multimedia equipment – Emission requirements) [17].

In the extended frequency band from 30 MHz to 100 MHz, which is used by new PLC adapters are allowed emission limits defined in two environment classes:

- emission class A, which are specified to protect industrial areas,
- emission class B, which are specified to protect residential, commercial and light-industrial environments.

An interference generated by voltage or current sources (using a connection cables and other conductive structures) radiates as disturbing electromagnetic field. There are dominant radiation emissions in the frequency band above 30 MHz.

## 2 Preparation for measurements with PLC adapters

The main aim of measurements of emitted electromagnetic radiation of PLC adapters was a consideration of interruption caused by these modems and how are they interrupting our network. In these measurements we used experiences obtained in previous testing of PLC adapters Corinex HD200 Powerline Wall Mount F, Corinex AV500 Powerline and ZyXEL HD Adapter Powerline PLA5215 [5].

### 2.1 Pc configuration setup

Before the communication between devices in our PLC network was necessary to set up some network parameters. The measurements were made on a computer with OS Windows where we set up features of *TCP/IPv4* protocol (*Start/Control panel/Network* and *Internet/Network Connections/Ethernet-Properties*). The configuration of network connection is shown in Tab. 1.

**Table 1.** Configuration of network connection

IP address:	10.10.1.1/10.10.1.2
Subnet mask:	255.255.0.0
Default gateway:	10.10.2.0

We used two PLC adapters ZyXEL PLA 5206 in these measurements. It is necessary to check if there is any blocking using antivirus software or Windows Firewall. If they are active it is necessary to deactivate them, because the incoming and outgoing traffic is blocked by them. After these settings are done it is possible to realize unlimited measurements in our PLC network.

### 2.2 Plc adapters ZyXEL PLA 5206

PLC adapters ZyXEL PLA 5206 should reach up to the theoretical transfer rate up to 1000 Mbps using electrical power network [34]. These adapters automatically support one type of traffic encryption and it is encryption standard AES with the key length of 128 bits. PLC adapters support so called “plug&play-capability” so after plugging them in the socket and connecting to our devices is automatically made a connection between these devices. They also support the HomePlug AV2 standard, which used the frequency band from 1.8 MHz to 86 MHz with transfer rate more than 600 Mbps.

## 3 The radiated emission measurement setup of PLC adapters

All measurements of disturbing voltage were made with PLC adapters ZyXEL PLA 5206. The measurements were realized in certified laboratory EMC (laboratory of electromagnetic compatibility) in the Institute of Electrical Engineering at Faculty of Electrical Engineering and Information Technology of Slovak University of Technology in Bratislava. The laboratory contains shielded semi-anechoic chamber lined by ferrite absorbing tiles and partially by pyramidal foam absorbers, so the test place meets the requirements of EN55016 for radiated emission measurement up to 18 GHz. A testing receiver was Rohde & Schwarz for the frequency range from 9 kHz up to 7 GHz.

The measurements were made in two terms. In the first term there was our whole workstation inside the shielded chamber with PLC adapters and notebooks too. In the second term there were just PLC adapters inside the chamber to eliminate the disturbance effect of notebooks.

## 4 The measurement with computers inside the shielded chamber

In this measurement is our complete workplace inside the EMC laboratory. The diagram of our workplace is shown in Fig. 1. PLC adapters were plugged in electrical network and connected to the computers via Ethernet interface. Computers were located on the ground to avoid their emission partially and to avoid the deformation of results. We used ferrite clamps to remove the emission of LAN cables.

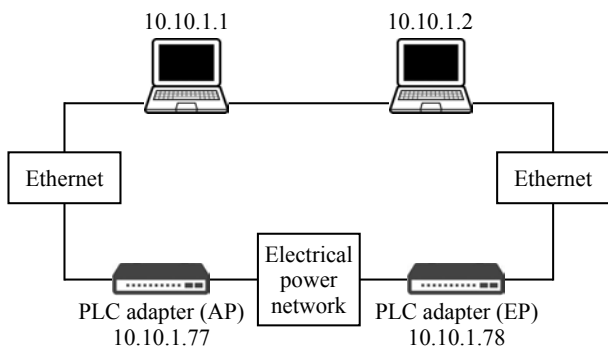

Fig. 1. Diagram of workplace used in EMC testing

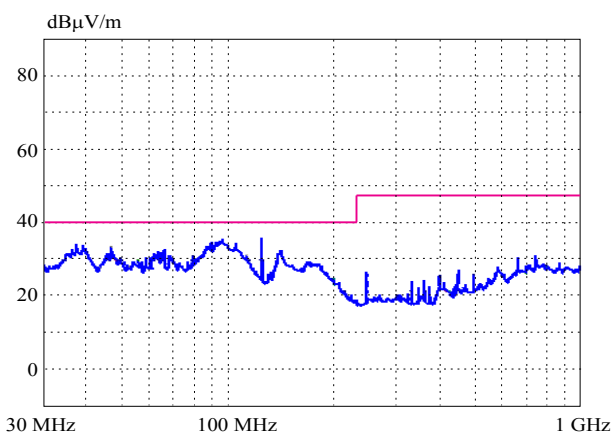

Fig. 2. Disturbing field tested by peak detector

We also used a peak detector to measuring radiated emission of PLC adapters when the value of output voltage is equal to the maximum value of voltage envelope. The reaction of the peak detector is fast and detector also save the maximum value of output in this method. This type of measurements is used in the primary testing of electromagnetic emissions. The disturbing field of this measurement is shown in Fig. 2. As we can see in Fig. 2 the output of peak detector is completely under the limit of 40 dBμV/m, what is the limit of acceptable value of disturbing field.

### 5 The measurements with computers outside the shielded chamber

We remodeled our workplace in this part of measurements to remove the possibility of disturbing emission by computers (laptops) in our PLC network. We put the computers outside the test chamber so inside the chamber were just PLC adapters and LAN cables. 230V network cable was shorted to 0.7 m active irradiated length. The location of the LAN cables inside the chamber was such that their radiated emissions were minimal and ferrite clamps were placed on the cables.

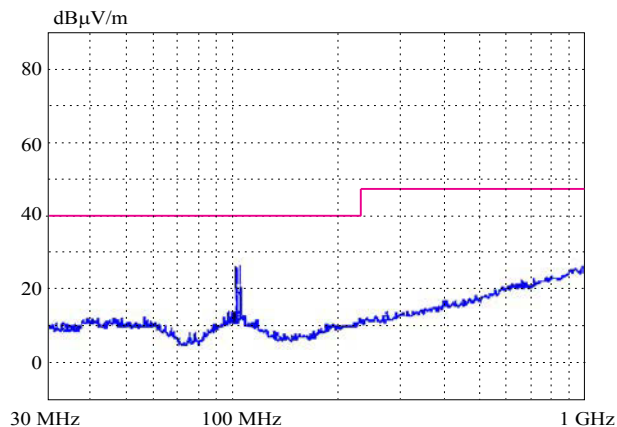

Fig. 3. The curve of LAN cables disturbing field – horizontal polarization

We made following measurements using a configuration with computers outside of shielded chamber:

- the disturbing field of PLC adapters in passive mode connected to network voltage 230 V,
- the disturbing field of LAN cables,
- the disturbing field of PLC adapters in passive mode connected to network voltage 230 V and LAN cables,
- the disturbing field of PLC adapters in active mode with multimedia traffic,
- the comparison of measured values of disturbing field using PLC adapters in passive/active mode.

As we said, there were just PLC adapters in these measurements connected via LAN cables with computers outside the laboratory in the shielded chamber. All of these measurements were made in the vertical and horizontal polarization of antenna.

### 6 The measurement of disturbing voltage of PLC adapters in passive mode connected to supply network

The main aim of this measurement was to detect radiated emission spectrum of PLC adapters in passive mode connected to network voltage 230 V. The measured values did not exceed the total noise background of the apparatus (more than 30 dB below limit B class). We can say, that PLC adapters in passive mode plugged in electrical network cause minimal emission and do not affect the function of other devices in network.

### 7 The measurement of disturbing field of LAN cables

The main goal of this measurement was the detection of disturbing voltage of LAN cables which are used to connect PLC adapters with laptops. The emission measurement of LAN cables had approximately similar output as PLC adapters in passive mode. The only difference is that there are some peaks near 100 MHz frequency. The entire curve of disturbing voltage is under the acceptable value

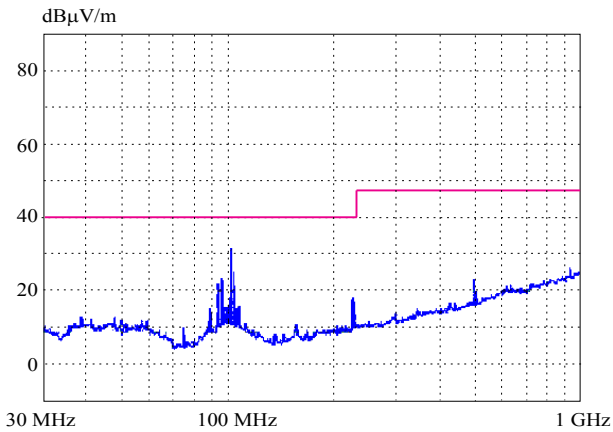

**Fig. 4.** The curve of LAN cables disturbing field – vertical polarization

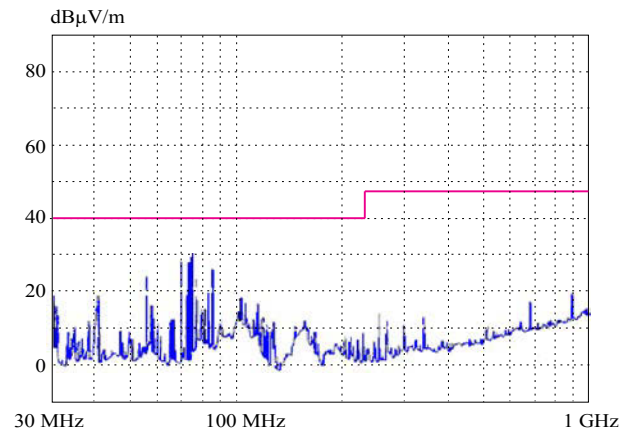

**Fig. 5.** The spectrum of disturbing field of PLC adapters in passive mode connected to network voltage 230 V and LAN cables – horizontal polarization

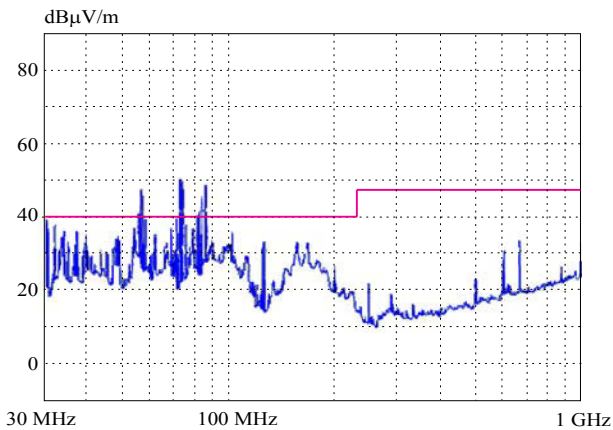

**Fig. 6.** The spectrum of disturbing field of PLC adapters in passive mode connected to network voltage 230 V and LAN cables – vertical polarization

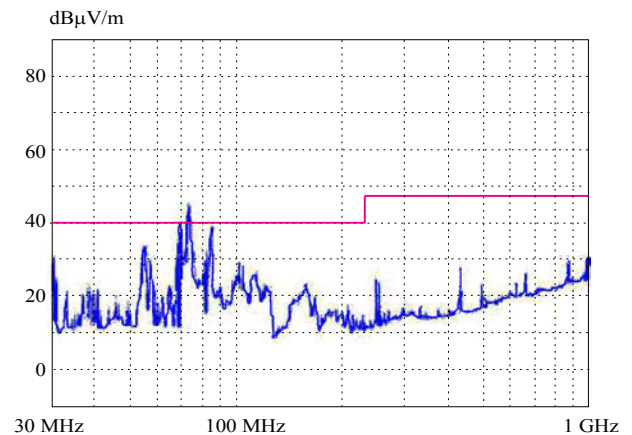

**Fig. 7.** The spectrum of disturbing field of PLC adapters in active mode with multimedia traffic – horizontal polarization

of disturbance limit  $40 \text{ dB}\mu\text{V/m}$ . The curve of LAN cables disturbing voltage in horizontal polarization is shown in Fig. 3 and disturbing field in vertical polarization is shown in Fig. 4.

### 8 The measurement of disturbing voltage of PLC adapters in passive mode connected to network voltage 230 V and LAN cables

In this part we made the measurements of disturbing field when we created a full-valued network consisted of two PLC adapters and two laptops but without multimedia traffic. We did not send any data to this network, the network was in passive mode. As we can see in Fig. 5 the emission spectrum of disturbing field has changed and there are bigger emissions as in previous measurements. The spectrum of disturbing field in horizontal polarization is still under the acceptable limit of emission ( $40 \text{ dB}\mu\text{V/m}$ ) so we can say that our created network did not affect the function of other devices significantly.

The results indicate that emissions could exceed the relevant limit ( $40 \text{ dB}\mu\text{V/m}$ ) in both horizontal polarization (Fig. 5) and vertical polarization (Fig. 6).

### 9 The measurement of disturbing field of PLC adapters in active mode with multimedia traffic

In this measurement we loaded our PLC network with the video stream. We used a serial in Full HD definition. The main goal of this measurement was to find out if the spectrum of disturbing field will change when we will be sending any data in our network. We also wanted to find out if the spectrum of disturbing field will change significantly when PLC adapters will be in active mode. We can see in Fig. 7, that the spectrum disturbing field of PLC network with multimedia traffic copies the spectrum from the previous measurement without traffic.

The results also indicate that emissions could exceed the relevant limit ( $40 \text{ dB}\mu\text{V/m}$ ) in both horizontal polarization (Fig. 7) and vertical polarization (Fig. 8).

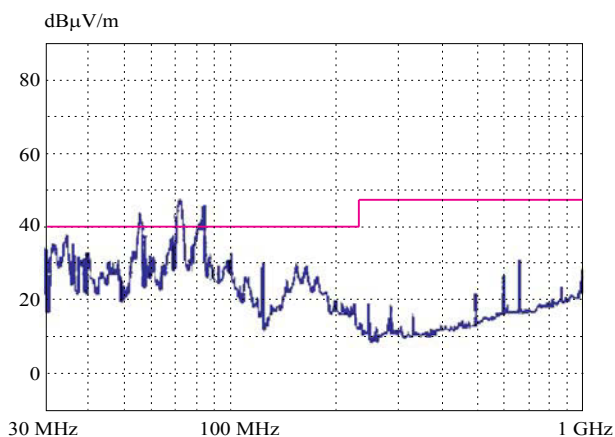

Fig. 8. The spectrum of disturbing field of plc adapters in active mode with multimedia traffic – vertical polarization

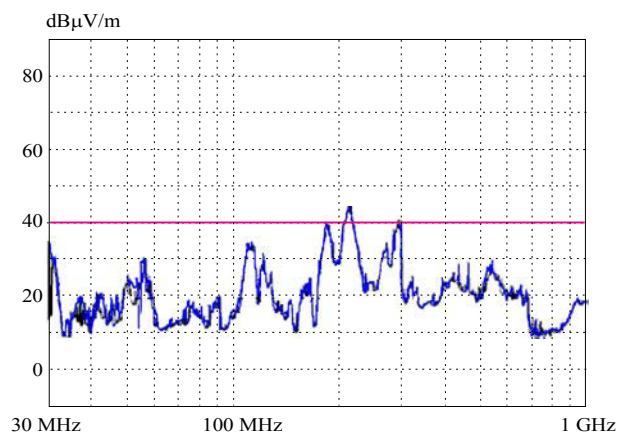

Fig. 9. The disturbing field comparison of PLC adapters in active (solid) and passive (dotted) mode – horizontal polarization

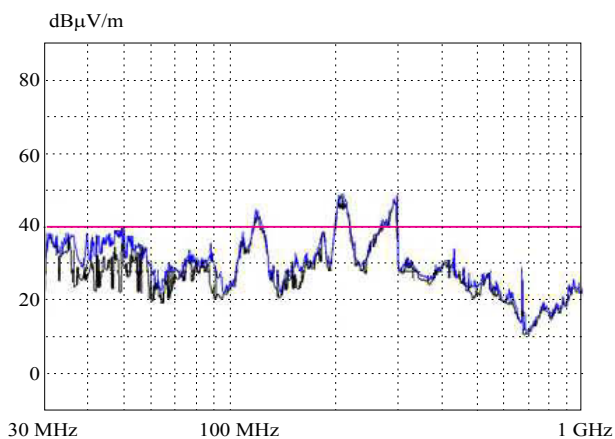

Fig. 10. The disturbing field comparison of PLC adapters in active (solid) and passive (dotted) mode – vertical polarization

### 10 The comparison of measured values of disturbing voltage using PLC adapters in passive/active mode

The attention of this measurement was aimed to a frequency range where are the changes of the spectrum of disturbing field significant. The measurement was made in the frequency band from 30 MHz to 150 MHz. The main goal of this measurement was to show the difference between PLC network in passive (without multimedia traffic) or in-active (with multimedia traffic) mode. We compared two types of spectrum of disturbing field which were added to a single diagram because of clarity. As we can see the diagram shown in Fig. 9, the difference between PLC network with or without multimedia traffic is minimal, so we can say that data transfer using PLC adapters do not affect the emission value of these adapters so much and do not affect the functioning of other devices in the network because the influencing is often attributed to the PLC adapters. The PLC network with multimedia traffic has a blue color in the diagram and the PLC network without multimedia traffic has a

black color in the diagram. The curves of disturbing field in horizontal polarization are shown in Fig. 9, in vertical polarization in Fig. 10.

### 11 Conclusions

Based on the measured radiated emission spectrums of disturbing voltage in horizontal and vertical polarization we can allege that PLC adapters ZyXEL PLA 5206 are electrical devices, which are interfering other devices with their emitted disturbing field just minimally because the peaks of disturbing field hardly even exceed the value of 40 dBμV/m what is the acceptable limit of disturbance. The measured spectra of disturbing field are expressively better than the measured spectra of PLC adapters Corinex HD200 Powerline Wall Mount F, Corinex AV500 Powerline and ZyXEL HD Adapter Powerline PLA5215, published in [9]. When testing PLC adapters we also measured the transfer rate. The tested adapters exploit “plug&play-capability” and support HomePlug AV2 standard which uses the frequency band from 1.8 MHz to 86 MHz. The maximum transfer rate was 635 Mbps in these measurements even if the theoretical transfer rate of these adapters is up to 1000 Mbps. The transfer rate of PLC network also depends on the architecture of used computers and devices connected to the electrical power network. This issue will be discussed in another article because of the great extent. Based on a comparison of obtained results, we can conclude that the ZyXEL PLA 5206 tested modems are characterized by less electromagnetic radiation than the modems tested in the previous work [5]. We assume that filtering has been improved in designing these modems to prevent the undesirable effects of electromagnetic radiation.

### Acknowledgements

This article was created with the support of the Ministry of Education, Science, Research and Sport of the Slo-

vak Republic within the VEGA agency project 1/0462/17 Modeling of qualitative parameters in IMS networks. The publication was prepared too with the support of the RUDN University Program 5-100.

## REFERENCES

- [1] M. Orgoň, R. Róka and J. Mišurec, “Smart Grid and PLC communications”, *STU Bratislava*.
- [2] J. Krejčí, T. Zeman and J. Hrad, “Impulse Noise Considerations Related to Data Transmission over High-Voltage Lines”, *Elektronika ir Elektrotechnika*, vol. 20, no. 8, 2014, <http://dx.doi.org/10.5755/j01.eee.20.8.8444>.
- [3] P. Mlýnek, R. Fujdiak, J. Mišurec and J. Sláčík, “Experimental Measurements of Noise Influence on Narrowband Power Line Communication”, *8th International Congress on Ultra Modern Telecommunications and Control Systems and Workshops (ICUMT) Lisabon*: pp. 1–7, 2016.
- [4] P. Mlýnek, J. Mišurec and M. Koutný, “Noise Modeling for Power Line Communication Model”, *35th International Conference on Telecommunications and Signal Processing (TSP)*, pp. 282–286, 2012.
- [5] F. Hossner, J. Hallon, M. Orgoň and R. Róka, “Testing of Electromagnetic Compatibility of PLC Modems”, *International Journal of Engineering Research & Technology (IJERT)*, vol. 5, no. 01, 2016.
- [6] J. Mišurec and M. Orgoň, “Modelling of Power Line Transfer of Data for Computer Simulation”, *International Journal of Communication Networks and Information Security (IJCNIS)* vol. 3, no. 2, pp. 104–111, Pakistan, 2011.
- [7] R. Róka, “The Environment of Fixed Transmission Media and Their Negative Influences the Simulation”, *International Journal of Mathematics and Computers Simulation – IJMCS*, vol. 9, pp. 190–205, 2015.
- [8] R. Róka, “Analysis of Advanced Modulation Techniques the Environment of Metallic Transmission Media”, *TSP 2014 - 37th International Conference on Telecommunications and Signal Processing*, Berlin (Germany), pp. 78–84, 2014.
- [9] R. Róka, “The Design of a PLC Modem and its Implementation Using FPGA Circuits”, *Journal of Electrical Engineering*, vol. 60, no. 1, pp. 43–47, 2009.
- [10] R. Róka and J. Urmínský, “Experimental Measurements for Verification of the Parametric Model for Reference Channels the Real PLC Environment”, *Journal of Electrical Engineering*, vol. 59, no. 3, pp. 146–152, 2008.
- [11] P. Mlýnek, R. Fujdiak and J. Mišurec, “Power Line Topology Prediction Using Time Domain Reflectometry”, *Proceedings of the 39th International Conference on Telecommunications and Signal Processing (TSP)*, pp. 199–202, 2016.
- [12] P. Mlýnek, J. Mišurec, R. Fujdiak and Z. Hasirci, “Analysis of Channel Transfer Functions Power Line Communication System for Smart Metering and Home Area Network”, *Advances Electrical and Computer Engineering*, vol. 16, no. 4, pp. 51–56, 2016.
- [13] P. Mlýnek, J. Mišurec, M. Koutný, R. Fujdiak and T. Jedlička, “Analysis and Experimental Evaluation of Power Line Transmission Parameters for Power Line Communication”, *Measurement Science Review*, vol. 15, no. 2, pp. 64–71, 2015.
- [14] P. Mlýnek, J. Mišurec, R. Fujdiak, Z. Kolka and L. Pospíchal, “Heterogeneous Networks for Smart Metering – Power Line and Radio Communication”, *Elektronika Ir Elektrotechnika*, vol. 21, no. 2, pp. 85–92, 2015.
- [15] P. Mlýnek, J. Mišurec, M. Koutný and R. Fujdiak, “Transfer Function of Power Line Channel – Influence of Topology Parameters and Power Line Topology Estimation”, *The 5th IEEE PES Innovative Smart Grid Technologies (ISGT) European 2014 Conference*, pp. 1–5.
- [16] P. Mlýnek, J. Mišurec and M. Koutný, “Measurement of Power Line Cable Parameters for PLC Model”, *Proceedings of 15th International Conference on Research Telecommunication Technologies*, pp. 1–3, 2013.
- [17] EN 55032, “Electromagnetic compatibility of multimedia equipment – Emission Requirements”, 2015.
- [18] S. Klucik, J. Taraba, I. Baronak and M. Orgon, “Quality of Service PLC Networks”, *Low-Power Horizon magazine*, 2012.
- [19] S. Klucik, E. Chromy and I. Baronak, “Model to Increase the Number of Output Sates of a Random Variable using a Histogram based PDF”, *Wireless Personal Communications*, vol. 85, no. 1, pp. 137–149, Springer, New York, 2015.
- [20] CISPR 13, “Sound and Television Broadcast Receivers and Associated Equipment – Radio Disturbance Characteristics - Limits and Methods of Measurement”, 2009.
- [21] CISPR 20, “Sound and Television Broadcast Receivers and Associated Equipment – Immunity Characteristics – Limits and Methods of Measurement”, 2006.
- [22] CISPR 22, “Information Technology Equipment – Radio Disturbance Characteristics – Limits and Methods of Measurement”, 2008.
- [23] CISPR, 24 and, “Information technology equipment - Immunity characteristics - Limits and methods of measurement”, , 2010.
- [24] “Electromagnetic Compatibility (EMC), Directive 2014/30/EU of the European Parliament and of the Council of 26 February 2014 on the Harmonisation of the Laws of the Member States Relating to Electromagnetic Compatibility (recast)”, 2014.
- [25] “STN EN 301 489-4 V2.2.1: Electromagnetic Compatibility and Radio Spectrum Matters (ERM); ElectroMagnetic Compatibility (EMC) Standard for Radio Equipment and Services”, *Part 4, Specific Conditions for Fixed Radio Links and Ancillary Equipment*, 2016.
- [26] “STN EN 50160 (33 0121): Voltage Characteristics of Electricity Supplied by Public Electricity Networks”, 2015.
- [27] “STN EN 50160 (33 0121): Voltage Characteristics of Electricity Supplied by Public Electricity Networks”, 2015.
- [28] “STN EN 301 489-1 V1.9.2: Electromagnetic Compatibility and Radio Spectrum Matters”, (ERM); ElectroMagnetic Compatibility (EMC) Standard for Radio Equipment and Services; Part 1: Common Technical Requirements, 2012.
- [29] “STN EN 61000-6-4: Electromagnetic compatibility (EMC)”, *Part 6-4: Generic standards – Emission standard for industrial environments*, 2007.
- [30] “STN EN 61000-6-2: Electromagnetic compatibility (EMC)”, *Part 6-2: Generic standards. Immunity for industrial environments*, 2006.
- [31] “STN EN 61000-2-2: Electromagnetic compatibility (EMC)”, *Part 2-2: Environment. Compatibility Levels for Low-Frequency Conducted Disturbances and Signaling Public Low-Voltage Power Supply Systems*, 2004.
- [32] “STN EN 61000-2-4: Electromagnetic Compatibility (EMC)”, *Part 2-4: Environment - Compatibility Levels Industrial Plants for Low-Frequency Conducted Disturbances*, 2003.
- [33] R. Roka, “Modeling of Environmental Influences at the Signal Transmission by means of the VDSL and PLC Technologies”, *International Journal of Electrical Communication Networks and Information Security - IJCNIS*, vol. 1, no. 1, 2009, pp. 6–13.
- [34] [https://www.zyxel.com/products\\_services/1000-Mbps-Powerline-Gigabit-Ethernet-Adapter-PLA5206/specifications](https://www.zyxel.com/products_services/1000-Mbps-Powerline-Gigabit-Ethernet-Adapter-PLA5206/specifications).

Received 30 October 2017